



Inspired by temperature

Betriebsanleitung · Operation manual · Manual de instrucciones · Manuel d'utilisation · Manuale de d'uso · 사용 설명서 · Manual de instruções · Инструкция по эксплуатации · Kullanım talimatı · 操作说明书 · Betriebsanweisung · Manual de instrucciones · Manuel d'utilisation · Manuale de d'uso · 사용 설명서 · Manual de instruções · Инструкция по эксплуатации · Kullanım talimatı · 操作说明书 · Betriebsanweisung · Manual de instrucciones · Manuel d'utilisation · Manuale de d'uso · 사용 설명서 · Manual de instruções · Инструкция по эксплуатации · Kullanım talimatı · 操作说明书

ColdTrap

This documentation does not contain a device-specific technical appendix.

You can request the full operating instructions from info@huber-online.com. Please give the model designation and serial number of your temperature control unit in your e-mail.

huber



OPERATION MANUAL

ColdTrap

ColdTrap

OLÉ

This operation manual is a translation of the original operation manual.

VALID FOR:

CT50
CT50 Single
CT50 Twin

The control panel:
Displays and keys

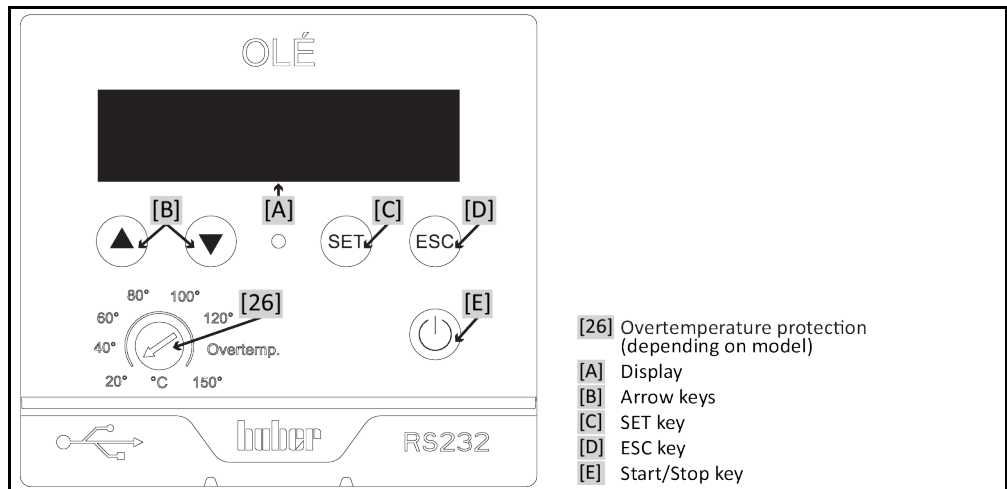

Table of contents

V1.1.0en/17.07.23//1.30

1	Introduction	12
1.1	Identification / symbols in the operation manual	12
1.2	Information on the EU Declaration of Conformity	12
1.3	Safety	12
1.3.1	Symbols used for Safety Instructions	12
1.3.2	Representation of symbols on the temperature control unit	13
1.3.3	Proper operation	14
1.3.4	Reasonably foreseeable misuse	14
1.4	Responsible bodies and operators – Obligations and requirements	15
1.4.1	Obligations of the responsible body	15
1.4.1.1	Proper disposal of resources and consumables	15
1.4.1.2	Temperature control units with natural refrigerants (NR)	16
1.4.2	Requirements for operators	17
1.4.3	Obligations of the operators	17
1.5	General information	17
1.5.1	Description of workstation	17
1.5.2	Safety devices to DIN 12876	17
1.5.3	Further protective devices	18
1.5.3.1	Power interruption	18
1.6	Exemplary illustrations of the cooling variants	19
2	Commissioning	20
2.1	In-plant transport	20
2.1.1	Lifting and transporting the temperature control unit	20
2.1.1.1	Temperature control unit with lifting eyes	20
2.1.1.2	Temperature control unit without lifting eyes	21
2.1.2	Mounting/removing leveling feet	21
2.1.3	Positioning the temperature control unit	22
2.1.3.1	Temperature control unit with casters	22
2.1.3.2	Temperature control unit without casters	22
2.2	Unpacking	22
2.3	Ambient conditions	22
2.3.1	EMC-specific notes	24
2.4	Installation conditions	24
2.5	Preparations for operation	25
2.5.1	Unscrewing/activating the leveling feet (if any)	25
2.5.2	Installing the glass accessory kit (optional)	25
2.5.3	Installing the application	25
2.5.4	Connecting the functional earth	26
2.6	Connecting to the power supply	26
2.6.1	Connection using socket with protective earth (PE)	26
2.6.2	Connection via hard wiring	27
3	Function description	28
3.1	Function description of the temperature control unit	28
3.1.1	General functions	28
3.1.2	Other functions	28

3.2	Information on the thermal fluids	28
3.3	To be noted when planning the test	29
3.4	Display and control instruments	29
3.4.1	Display	29
3.4.2	Control instruments	30
3.4.2.1	Arrow keys	30
3.4.2.2	SET key	30
3.4.2.3	ESC key	31
3.4.2.4	Start/Stop key	31
3.4.3	Adjusting settings	31
3.5	Menu function	32
3.6	Functional examples	33
3.6.1	Selecting a language	33
3.6.2	Setting the setpoint	33
3.6.3	Changing the Auto-Start function	33
4	Setup mode	34
4.1	Setup mode	34
4.1.1	Turning on the temperature control unit	34
4.1.2	Turning off the temperature control unit	34
5	Normal operation	35
5.1	Automatic operation	35
5.1.1	Temperature control	35
5.1.1.1	Starting the temperature control process	35
5.1.1.2	Ending the temperature control process	35
6	Interfaces and software update	36
6.1	Controller interfaces	36
6.1.1	USB-2.0 interface	36
6.1.1.1	USB-2.0 interface, device	36
6.1.2	RS232 jack	36
6.2	Data communication	37
6.2.1	LAI commands	37
6.2.1.1	Command "V" (Verify)	38
6.2.1.2	Command "L" (Limit)	38
6.2.1.3	Command "G" (General)	39
6.2.2	PP commands	40
7	Service/maintenance	42
7.1	Displays in the event of faults	42
7.2	Electrical fuse (if available)	43
7.3	Maintenance	43
7.3.1	Function check and visual inspection	43
7.3.2	Clean liquefier fins (air-cooled temperature control unit)	44
7.4	Cleaning the surfaces	45
7.5	Plug contacts	45
7.6	Decontamination/repairs	45
8	Shutting down	46
8.1	Safety instructions and basic principles	46
8.2	Switch-off	46
8.3	Emptying the application	46

8.4	Uninstalling the application.....	46
8.5	Packing	47
8.6	Shipping.....	47
8.7	Disposal	47
8.8	Contact data	48
8.8.1	Telephone number: Customer Support	48
8.8.2	Telephone number: Sales	48
8.8.3	Email address: Customer Support.....	48
8.9	Clearance certificate.....	48
9	Annex	49

Foreword

Dear customer,

Thank you for choosing a temperature control unit from Peter Huber Kältemaschinenbau SE. You have made a good choice. Thank you for your trust.

Please read the operation manual carefully before putting the unit into operation. Strictly follow all notes and safety instructions.

Follow the operation manual with regard to transport, start-up, operation, maintenance, repair, storage and disposal of the temperature control unit.

We fully warrant the temperature control unit for the specified intended operation.

The models listed on page 5 are referred to in this operation manual as temperature control units and Peter Huber Kältemaschinenbau AG as Huber company or Huber.

Liability for errors and misprints excluded.

The following trademarks and the Huber logo are registered trademarks of Peter Huber Kältemaschinenbau SE in Germany and/or other countries worldwide: BFT®, CC®, Chili®, Com.G@te®, Compatible Control®, CoolNet®, DC®, E-grade®, Grande Fleur®, Huber Piccolo®, KISS®, Minichiller®, Ministat®, MP®, MPC®, Peter Huber Minichiller®, Petite Fleur®, Pilot ONE®, RotaCool®, Rotostat®, SpyControl®, SpyLight®, Tango®, TC®, UC®, Unical®, Unichiller®, Unimotive®, Unipump®, Unistat®, Unistat Tango®, Variostat®. The following trademarks are registered in Germany to DWS Synthesetechnik: DW-Therm®, DW-Therm HT®. The following trademark is a registered trademark of BASF SE: Glysantin®.

1 Introduction

1.1 Identification / symbols in the operation manual

The following identifications and symbols are used in the texts and illustrations.

Overview	Identification / symbol	Description
	→	Reference to information / procedure.
	»TEXT«	Reference to a chapter in the operation manual. In the digital version, the text is clickable.
	>TEXT< [NUMBER]	Reference to the wiring diagram in the annex. The designation and the search digit are specified.
	>TEXT< [LETTER]	Reference to a drawing in the same paragraph. The designation and the search digit are specified.
	▪	List, first level
	–	List, second level

1.2 Information on the EU Declaration of Conformity



The equipment complies with the basic health and safety requirements of the European Directives listed below:

- Machinery Directive
- Low Voltage Directive
- EMC Directive

1.3 Safety

1.3.1 Symbols used for Safety Instructions

Safety instructions are marked by the below combinations of pictograms and signal words. The signal word describes the classification of the residual risk when disregarding the operation manual.



Denotes an immediate hazardous situation that will result in death or serious injuries.



Denotes a general hazardous situation that may result in death or serious injuries.



Denotes a hazardous situation that can result in injury.



Denotes a situation that can result in property material damage.



Denotes important notes and usable hints.



Notes in conjunction with Ex px cabinets.

Safety information and procedure

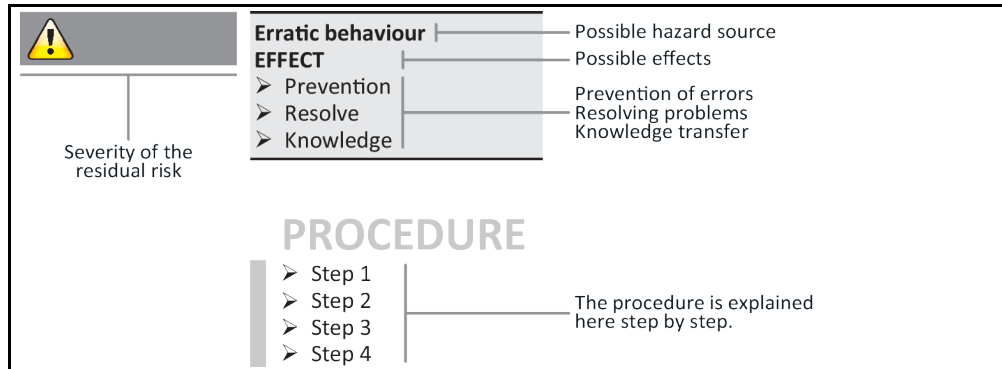

The safety information in this operation manual is designed to protect the operating company, the operator and the equipment from damage. First inform yourself about any residual risks due to misuse before you start an operation.

1.3.2 Representation of symbols on the temperature control unit

The following pictograms are used as safety identifiers. The table gives an overview of the safety identifiers used here.

Identifier	Description
Mandatory sign	
	- Observe the instructions
Warning sign	
	- General warning sign - Observe the instructions
	- Warning of electrical voltage
	- Warning of hot surface
	- Warning of flammable substances
Miscellaneous	
	Follow the national and local instructions for the disposal of electrical appliances. → Page 47, section »Disposal«

1.3.3 Proper operation



Operating the temperature control unit in a potentially explosive area

DEATH THROUGH EXPLOSION

- Do NOT install or start up the temperature control unit within an ATEX zone.



Improper use

SERIOUS INJURY AND PROPERTY DAMAGE

- Store the operation manual where it is easy to access in close proximity to the temperature control unit.
- Only adequately qualified operators may work with the temperature control unit.
- Operators must be trained before handling the temperature control unit.
- Check that the operators have read and understood the operation manual.
- Define precise responsibilities of the operators.
- Personal protective equipment must be provided to the operators.
- Be sure to follow the responsible body's safety rules to protect life and limb and to limit damages!



Modifications to the temperature control unit by third-parties

DAMAGE TO THE TEMPERATURE CONTROL UNIT

- Do not allow third parties to make technical modifications to the temperature control unit.
- The EU declaration of conformity becomes invalid if any modifications are made to the temperature control unit without the approval of Huber.
- Only specialists trained by Huber may carry out modifications, repairs or maintenance work.
- **The following must be observed without fail:**
- Only use the temperature control unit in a fault-free condition!
- Have the start-up and repairs carried out by specialists only!
- Do not ignore, bypass, dismantle or disconnect any safety devices!

The temperature control unit must not be used for any purposes other than temperature control in accordance with the operation manual.

The temperature control unit is made for industrial use. The temperature control unit is solely intended as a cooling device for cooling liquids in containers. The containers used must be resistant to temperature and thermal fluids. The temperature control unit does not have an overtemperature protection and must be additionally protected when used with heating elements. Note the temperature control unit's maximum operating temperature. The installation in public buildings is prohibited. Only use thermal fluids suitable for the overall system. The cooling capacity is provided at the >Probe< [67]. For the technical specification, refer to the datasheet. → From page 49, section »Annex«. Install, set up and operate the temperature control unit according to the instructions in this operation manual. Any failure to comply with the operation manual is considered as improper operation. The temperature control unit was manufactured according to the state of the art and the recognized safety rules and regulations. Safety devices are installed in your temperature control unit.

1.3.4 Reasonably foreseeable misuse



Without an Ex px cabinet, the temperature control unit / accessory is **NOT** protected against explosion and must **NOT** be installed or put into operation within an ATEX Zone. When operating the temperature control unit /accessory in conjunction with an Ex px cabinet, the information in the annex (Section ATEX operation) must be observed and followed. This annex is only provided for temperature control units /accessories delivered with an Ex px cabinet. If this annex is missing, please immediately contact the Customer Support. → Page 48, section »Contact data«.

Use with medical devices (e.g. in Vitro diagnostic procedure) or for direct foodstuff temperature control is **NOT** permissible.

The temperature control unit must **NOT** be used for any purposes other than temperature control in accordance with the operation manual.

The manufacturer accepts **NO** liability for damage caused by **technical modifications** to the temperature control unit, **improper handling** or use of the temperature control unit if the operation manual is **not observed**.

1.4 Responsible bodies and operators – Obligations and requirements

1.4.1 Obligations of the responsible body

The operation manual is to be stored where it is easy to access in close proximity to the temperature control unit. Only adequately qualified operators (e.g. chemists, CTA, physicists etc.) are permitted to work with the temperature control unit. Operators must be trained before handling the temperature control unit. Check that the operators have read and understood the operation manual. Define precise responsibilities of the operators. Personal protective equipment must be provided to the operators.

- The responsible body must install a condensation water / thermal fluid drip tray below the temperature control unit.
- The use of a drip tray may be prescribed by national legislation for the installation area of the temperature control unit (incl. accessory). The responsible body must check and apply the national regulations applicable for it accordingly.
- The temperature control unit complies with all applicable safety standards.
- Your system, which uses our temperature control unit, must be equally safe.
- The responsible body must design the system to ensure it is safe.
- Huber is not responsible for the safety of your system. The responsible body is responsible for the safety of the system.
- Although the temperature control unit provided by Huber meets all the applicable safety standards, integration into a system may give rise to hazards that are characteristic of the other system's design and beyond the control of Huber.
- It is the responsibility of the system integrator to ensure that the overall system, into which this temperature control unit is integrated, is safe.
- The **>Mains isolator<** [36] (if present) can be locked in the off position to facilitate safe system installation and maintenance of the temperature control unit. It is the responsibility of the responsible body to develop any lock-out/tag-out procedure for the energy source in accordance with local regulations (e.g. CFR 1910.147 for the US).

1.4.1.1 Proper disposal of resources and consumables

Do comply with all national disposal regulations applicable for you. Contact your local waste management company for any questions concerning disposal.

Overview	Material / Aids	Disposal / Cleaning
	Packaging material	Keep the packaging material for future use (e.g. transport).
	Thermal fluid	Please refer to the safety data sheet of the thermal fluid used for information on its proper disposal. Use the original thermal fluid container when disposing it.
	Filling accessories, e.g. beaker	Clean the filling accessories for reuse. Make sure that the materials and cleaning agents used are properly disposed of.
	Aids such as towels, cleaning cloths	Tools used to take up spilled thermal fluid must be disposed of in the same fashion as the thermal fluid itself. Tools used for cleaning must be disposed of depending on the cleaning agent used.
	Cleaning agents such as stainless steel cleaning agents, sensitive-fabrics detergents	Please refer to the safety data sheet of the cleaning agent used for information on its proper disposal. Use the original containers when disposing of large quantities of cleaning agents.
	Consumables such as air filter mats, temperature control hoses	Please refer to the safety data sheet of the consumables used for information on their proper disposal.

1.4.1.2 Temperature control units with natural refrigerants (NR)



Over 8 g refrigerant per m³ room air
DEATH OR SERIOUS INJURY DUE TO EXPLOSION

- Observe the rating plate (amount of natural refrigerant contained) and the room size (maximum room concentration of natural refrigerant in case of leakage) when installing the temperature control unit.
- Over 8 g refrigerant per m³ room air: A gas warning sensor must be fitted and functioning.
- The gas warning sensor must be calibrated and maintained at regular intervals (between 6 and 12 months).
- The temperature control unit is not approved for operation **in an ATEX zone**.

Huber products with natural refrigerants work with numerous proven, safe and highly-sustainable technologies. The relevant standards and regulations for temperature control units with natural refrigerants contain a number of stipulations, the importance of complying with which is set out below. Please additionally: → Page 14, section »**Proper operation**«.

Huber temperature control units are constructed to be permanently sealed and are carefully checked for leak tightness. Temperature control units with more than 150 g natural refrigerant are equipped with an additional gas warning sensor.

For the filling capacity of the temperature control unit, refer to the data sheet. → From page 49, section »**Annex**«. Or to the rating plate on the back of the temperature control unit. Please also consider: → Page 22, section »**Ambient conditions**« and → Page 24, section »**Installation conditions**«.

Classifying the application field

Class of application field	Application field	Example of the installation location	Max. quantity of refrigerant	AND	Max. permissible quantity above ground level (GL)
A	General	Publicly accessible area in a public building	8 g/m ³ ambient air		1.5 kg
B	Monitored	Laboratories			2.5 kg
C	Access only for authorized persons	Production equipment			10.0 kg
Temperature control units with more than 1 kg refrigerant must not be installed below ground level (GL) .					

Temperature control units with up to 150 g natural refrigerant

- The temperature control unit has been constructed to the requirements of EU and EFTA countries.
- Use the table as guidance for classifying the application field. Respect the max. refrigerant quantity stated therein.

Temperature control units with more than 150 g natural refrigerant

- The temperature control unit has been constructed to the requirements of EU and EFTA countries.
- Use the table as guidance for classifying the application field. Respect the max. refrigerant quantity or the permissible highest quantity above ground level (GL) stated therein.
- For more information about the pre-installed gas detection sensor:
 - The built-in gas detection sensor enables a **safety shutdown at 20% of the lower explosive limit via a power disconnect relay that is to be installed by the responsible body**. The temperature control unit is thus switched off early and safely in case of fault.
 - A **24 V DC external power supply** must be available for the pre-installed gas warning sensor. The alarm output of the gas warning sensor uses a 4 - 20 mA signal. Please refer to the data sheet of the gas warning sensor for further technical information. A **separate processing unit is available as an accessory** for the control of the power disconnect relay. The processing unit provides a potential-free switching contact and simultaneously provides the power supply and analysis of the gas warning sensor. Both variants require the responsible body to provide the necessary dimensioning and installation. Please refer to the data sheet of the gas warning sensor for the technical information necessary for the installa-

tion. The alarm of the gas detection system can be connected to the responsible body's alarm control unit. The responsible body is responsible for this and for the other measures.

- The responsible body is responsible for the **calibration of the gas detection sensor** prior to initial operation and the observance of calibration and maintenance intervals according to the operation manual. We recommend to set calibration and maintenance intervals between 6 and 12 months if no information is provided. For increased safety requirements, shorter intervals can be specified. On request we will recommend a specialist company to carry out the calibration and maintenance.

1.4.2 Requirements for operators

Work on the temperature control unit is reserved for appropriately qualified specialists, who have been assigned and trained by the responsible body to do so. Operators must be at least 18 years old. Under 18-year olds may operate the temperature control unit only under the supervision of a qualified specialist. The operator is responsible vis-a-vis third-parties in the work area.

1.4.3 Obligations of the operators

Carefully read the operation manual before operating the temperature control unit. Please observe the safety instructions. When operating the temperature control unit, wear appropriate personal protective equipment (e.g. safety goggles, protective gloves, non-slip shoes).

1.5 General information

1.5.1 Description of workstation

The workstation is located at the control panel in front of the temperature control unit. The workstation is determined by the customer's connected peripheries. Accordingly, it must be designed safe by the responsible body. The workstation design also depends on the applicable requirements of the German occupational health and safety regulations [BetrsichV] and the risk analysis for the workstation.

1.5.2 Safety devices to DIN 12876



The temperature control unit is operated with a heating element without additional protection.

RISK OF INJURY

- The temperature control unit does **not** have an overtemperature protection and must be **additionally protected** when used with heating elements.
- Note the temperature control unit's maximum operating temperature. For the values, refer to the datasheet. → From page 49, section »Annex«.

The rating of your temperature control unit is stated on the data sheet in the appendix.

Rating of laboratory thermostats and laboratory baths	Classification	Temperature control medium	Technical requirements	Identification ^{d)}
	I	Non-combustible ^{a)}	Overheat protection ^{c)}	NFL
	II	Combustible ^{b)}	Adjustable overheat protection	FL
	III	Combustible ^{b)}	Adjustable overtemperature protection and additional low-level protection	FL
^{a)} Usually water; other fluids only if non-combustible even within the temperature range of an individual fault. ^{b)} The temperature control media must have a fire point of ≥ 65 °C. ^{c)} The overheat protection can, for instance, be realized using a suitable fill level sensor or a suitable temperature limiter. ^{d)} Optional at the choice of the manufacturer.				

- Temperature control units with heating correspond to class number III/FL. These temperature control units are characterized by an "H" in the device name.
- Temperature control units without heating correspond to class number I/NFL.

Overview of the temperature thresholds. The setpoint can only be changed for temperature control units with MPC controller

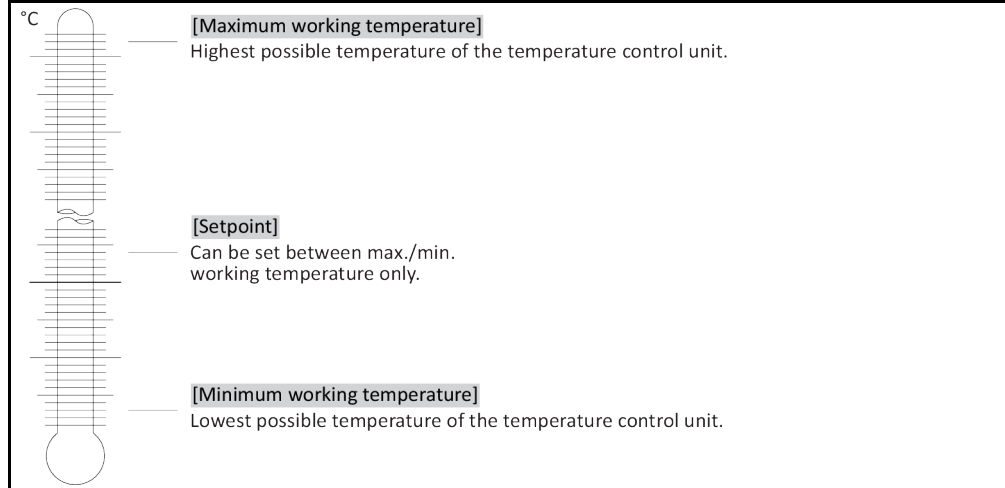

1.5.3 Further protective devices

INFORMATION

Emergency strategy – interrupt the power grid connection!

To determine the type of switch used or the switch combination installed, please refer to the connection sketch. → From page 49, section »Annex«.

Overview of switch types

Switch	Designation	Interrupting the power grid connection
	>Mains isolator< [36] (red-yellow) or >Mains isolator< [36] (grey)	Turn the >Mains isolator< [36] to the "0" position.
	>Mains isolator< [36] (red-yellow) and additional >Appliance switch< [37] (gray):	Turn the >Mains isolator< [36] to the "0" position, then the >Appliance switch< [37] to the "0" position.
	>Emergency stop switch< [70] (red-yellow) and >Mains isolator< [36] (gray):	Press the >Emergency stop switch< [70], then set the >Mains isolator< [36] to the "0" position.
	>Power switch< [37]	Power connection via socket: Pull the plug, then set the >Power switch< [37] to the "0" position. Connection via hard wiring: Use the building's circuit breaker, then set the >Power switch< [37] to the "0" position.
–	Without a switch or inside a protective housing	Power connection via socket: Pull the plug. Power connection via hard wiring: Use the building's circuit breaker.

1.5.3.1 Power interruption

Following a power outage (or when switching on the temperature control unit), this function can be used to determine how the temperature control unit is supposed to respond.

Auto start function switched off

The temperature control is started only by manual input when the temperature control unit is turned on.

Auto start function switched on

The temperature control unit is set to the same state it was in before the power outage. For example, before the power outage: Temperature control is off; after power outage: Temperature control is off. If temperature control was active during a power outage, the process will automatically continue after the power outage.

→ Page 33, section »Changing the Auto-Start function«.

1.6 Exemplary illustrations of the cooling variants

Example: Air and water cooling

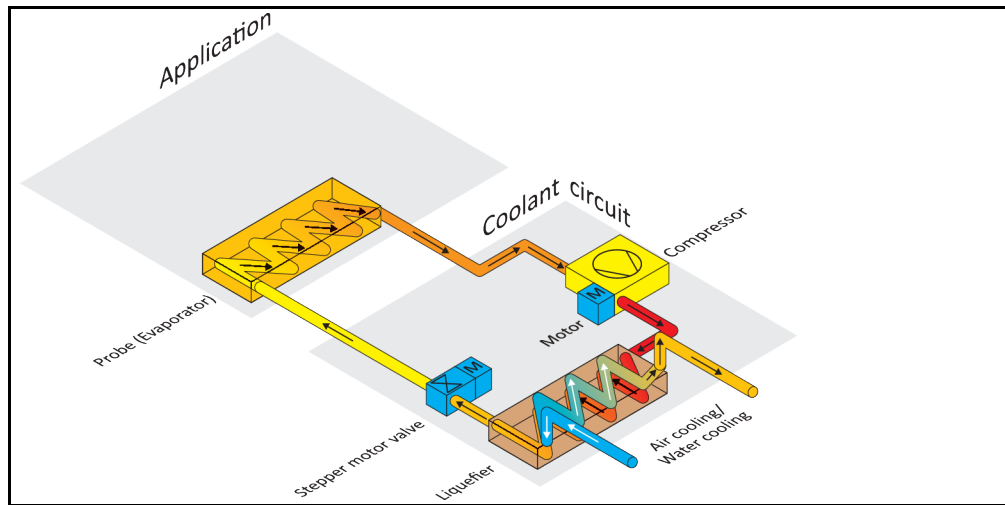

Air cooling: Air inlet

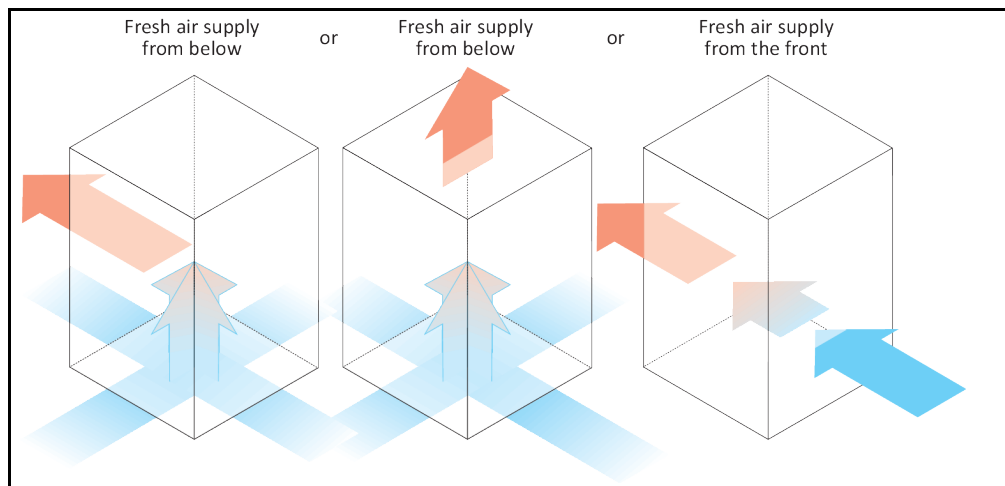

2 Commissioning

2.1 In-plant transport

WARNING

Temperature control unit is not transported / moved according to the specifications in this operation manual

DEATH OR SERIOUS INJURY DUE TO CRUSHING

- Always transport / move the temperature control unit according to the specifications in this operation manual.
- Wear personal protective equipment during transport.
- Always work with the specified number of persons when moving the temperature control unit on casters (if any).
- If the temperature control unit is equipped with casters and parking brakes: 2 parking brakes are always freely accessible when moving the temperature control unit. Activate the **2 parking brakes** in an emergency! If only **one** parking brake is activated on the casters in an emergency: The temperature control unit is not stopped but rotates around the axis of the caster with the activated parking brake!

NOTE

Temperature control unit transported in a horizontal position

DAMAGE TO THE COMPRESSOR

- Only transport the temperature control unit in an upright position.

NOTE

Filled temperature control unit is transported

MATERIAL DAMAGE DUE TO OVERFLOWING THERMAL FLUID

- Only transport an emptied temperature control unit.

- If available, use the lugs on the top side of the temperature control unit for transportation.
- Use an industrial truck for transport.
- The casters (if present) on the temperature control unit are not suitable for transport. The casters are symmetrically loaded with 25% of the total mass of the temperature control unit.
- Remove the packing material (e.g. the palette) only at the place of installation.
- Protect the temperature control unit from transport damage.
- Do not transport the temperature control unit alone and without aids.
- Check the load bearing capacity of the transportation route and the place of installation.
- The parking brakes at the casters (if any) must be activated and/or the leveling feet (if any) must be unscrewed/activated before the temperature control unit is put into operation. → Page 25, section »Unscrewing/activating the leveling feet (if any)«.

2.1.1 Lifting and transporting the temperature control unit

2.1.1.1 Temperature control unit with lifting eyes

NOTE

The temperature control unit is raised at the lifting eyes without load handling attachments

DAMAGE TO THE TEMPERATURE CONTROL UNIT

- Always use load handling attachments when lifting and transporting the temperature control unit.
- The lifting eyes are only designed for a load **without** inclination (0°).
- The load handling attachment used must be adequately dimensioned. Take the dimensions and weight of the temperature control unit into account.

Example: lifting eyes (round, angular, and recessed (left to right))

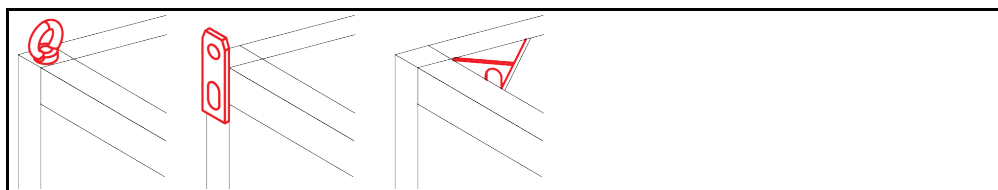

- Do not lift and transport the temperature control unit at the lifting eyes alone and without aids.
- Lift and transport the temperature control unit at the lifting eyes only with a crane or an industrial truck.
- The crane or industrial truck must have a lifting force equal to or greater than the weight of the temperature control unit. See the data sheet for the weight of the temperature control unit. → From page 49, section »Annex«.
- If the leveling feet have been removed for shipping: Only lower the temperature control unit when all leveling feet have been installed. → Page 21, section »Mounting/removing leveling feet«.

2.1.1.2 Temperature control unit without lifting eyes

Example: Supporting points for forklift arms for free-standing models from a certain overall size. For the exact position please refer to the wiring diagram in the annex.

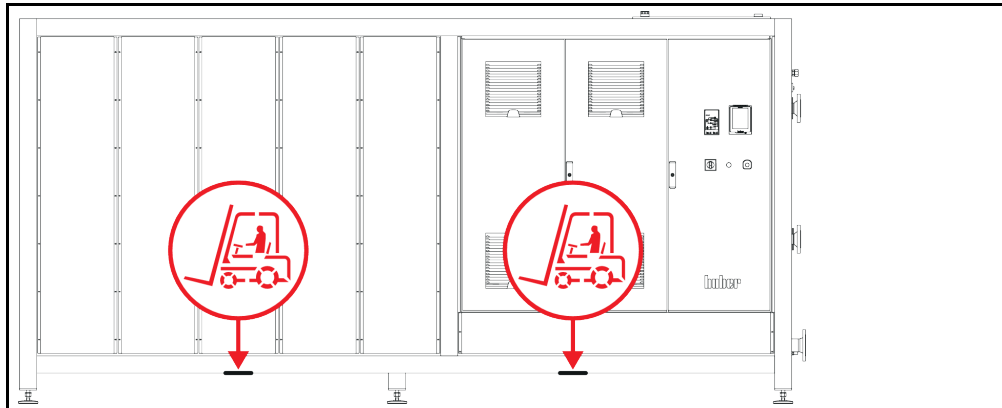

- Do not lift and transport the temperature control unit alone and without aids.
- Lift and transport the temperature control unit only with an industrial truck.
- The industrial truck must have a lifting force equal to or greater than the weight of the temperature control unit. See the data sheet for the weight of the temperature control unit. → From page 49, section »Annex«.
- If the leveling feet have been removed for shipping: Only lower the temperature control unit when all leveling feet have been installed. → Page 21, section »Mounting/removing leveling feet«.

2.1.2 Mounting/removing leveling feet

Only valid if the leveling feet have been removed for shipping.



WARNING

**The temperature control unit is not secured against slipping and/or lowering
DEATH OR SERIOUS INJURY DUE TO CRUSHING**

- Secure the temperature control unit against slipping and/or lowering before the leveling feet are mounted.
- Do not stand or lie under the temperature control unit for mounting.

Example: mounting the leveling feet

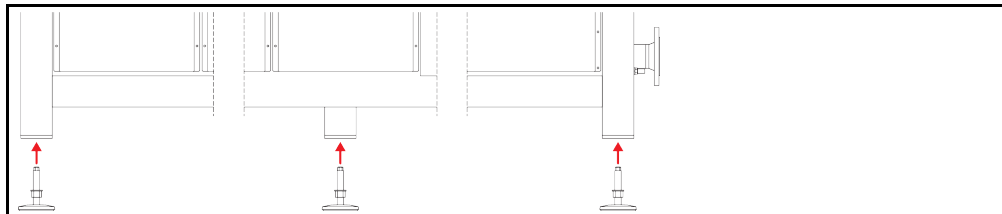

INFORMATION

The leveling feet were removed for shipping the temperature control unit. Before placing / positioning the temperature control unit all leveling feet must be mounted. If the temperature control unit is re-shipped: Remove all leveling feet before packaging.

- The leveling feet can only be mounted while the temperature control unit is lifted.
- Secure the temperature control unit against slipping and/or lowering.
- Do not stand or lie under the temperature control unit while mounting the leveling feet.
- Do not lower the temperature control unit until all leveling feet have been mounted.

2.1.3 Positioning the temperature control unit

2.1.3.1 Temperature control unit with casters

- Do **not** use the casters for the transportation to the place of installation. → Page 20, section »**Lifting and transporting the temperature control unit**«.
- Use the casters only for positioning at the place of installation.
- Only ever move the temperature control unit on the casters if the surface is level, without gradient, non-slip and stable.
- Do not move the temperature control unit alone.
- **At least 2 persons** are required to move the temperature control unit on casters. **At least 5 persons** are required to move the temperature control unit on the casters if the total weight of the temperature control unit is **over 1.5 tons**.
- The parking brakes must be activated at the casters and/or the feet (if present) must be unscrewed/activated before the temperature control unit is put into operation. → Page 25, section »**Unscrewing/activating the leveling feet (if any)**«.

2.1.3.2 Temperature control unit without casters

- An industrial truck must be used for positioning the temperature control unit.
- Do not move the temperature control unit alone.
- **At least 2 persons** are required to move the temperature control unit.
- The industrial truck must have a lifting force equal to or greater than the weight of the temperature control unit. See the data sheet for the weight of the temperature control unit. → From page 49, section »**Annex**«.
- The leveling feet (if present) must be unscrewed/activated before the temperature control unit is put into operation. → Page 25, section »**Unscrewing/activating the leveling feet (if any)**«.

2.2 Unpacking



WARNING

Starting up a damaged temperature control unit

DANGER TO LIFE FROM ELECTRIC SHOCK

- Do not operate a damaged temperature control unit.
- Please contact Customer Support. → Page 48, section »**Contact data**«.

PROCEDURE

- Check for damage to the packaging. Damage can indicate material damage to the temperature control unit.
- Check for any transport damage when unpacking the temperature control unit.
- Always contact your forwarding agent regarding the settlement of claims.
- Observe the proper disposal of packaging material. → Page 15, section »**Proper disposal of resources and consumables**«.

2.3 Ambient conditions



CAUTION

Unsuitable ambient conditions / unsuitable installation

SERIOUS INJURY DUE TO CRUSHING

- Comply with all requirements! → Page 22, section »**Ambient conditions**« and → Page 24, section »**Installation conditions**«.

INFORMATION

Make sure there is adequate fresh air available at the site for the circulation pump and the compressors. The warm exhaust air must be able to escape upwards unhindered.

Free-standing models

For the connection data, see the data sheet. → From page 49, section »**Annex**«.

Use of the temperature control unit is permitted only under normal ambient conditions in accordance with the currently valid DIN EN 61010-1.

- Use only indoors. The illuminance must be at least 300 lx.
- Installation altitude up to 2,000 meters above sea level.
- Maintain wall and ceiling clearance for adequate air exchange (dissipation of waste heat, supply of fresh air for the temperature control unit and work area). Ensure adequate floor clearance for air-cooled temperature control units. Do not operate this temperature control unit from within the box or with an inadequately dimensioned bath. This inhibits the air exchange.
- Ambient temperature values are provided on the technical data sheet; to ensure trouble-free operation, compliance with the ambient conditions is mandatory.
- Relative humidity max 80% to 32 °C and 40 °C decreasing linearly to 50%.
- Short distance to supply connections.
- The temperature control unit must not be installed so as to hinder or even prevent access to the disconnecting device (to the power supply).
- For the magnitude of the mains voltage fluctuations, refer to the datasheet. → From page 49, section »Annex«.
- Transient surges, as would normally occur in the power supply system.
- Installation Class 3
- Applicable degree of soiling: 2.
- Surge category II.

Please also note: → Page 19, section »Exemplary illustrations of the cooling variants«.

Wall clearances

Distance in cm	
Side	
[A2] Top	free standing
[B] Left	min. 20
[C] Right	min. 20
[D] Front	min. 20
[E] Rear	min. 20
Distance in cm (for operation in a bath)	
Side	
[A2] Top	free standing
[B] Left	min. 20
[C] Right	min. 20
[D] Front	min. 20
[E] Rear	min. 20

2.3.1 EMC-specific notes

INFORMATION

Connecting cables in general

Prerequisites for a failure-free operation of the temperature control units incl. their connections with external applications: Installation and wiring must be carried out professionally. Related topics: "Electrical safety" and "EMC-compliant wiring".

Cable lengths

For flexible/fixe cable routing of more than 3 meters, the following must amongst other things be observed:

- Equipotential bonding, grounding (see also technical data sheet "Electromagnetic compatibility EMC")
- Compliance with "external" and/or "internal" lightning/overvoltage protection.
- Design protection measures, professional cable selection (UV resistance, steel pipe protection, etc.)

Attention:

The operating company is responsible for compliance with national/international directives and laws. This also includes the testing of the installation/wiring required by law or standards.

This device is suitable for operation in "industrial electromagnetic environments". It meets the "immunity requirements" of the currently applicable EN61326-1, which are required for this environment.

It also meets the "interference emission requirements" for this environment. It is a Group 1 and Class A device according to the currently applicable EN55011.

When operating the temperature control unit in another environment, its electromagnetic compatibility can in rare cases not be ensured.

Group 1 specifies that high frequency (HF) is only used for the function of the device. Class A defines the interference emission limits to be observed.

2.4 Installation conditions

 **WARNING**

Temperature control unit is connected to the power supply line

DEATH FROM ELECTRICAL SHOCK BY DAMAGE TO THE POWER CABLE.

- Do not put temperature control unit on power cable.

 **CAUTION**

Operating the temperature control unit fitted with casters without brakes activated

CRUSHING OF LIMBS

- Activate brakes on the casters.

- Allow the temperature control unit to acclimate for about 2 hours when changing from a cold to a warm environment (or vice versa). Do not turn on the temperature control unit before!
- Install upright, stable and tilt-resistant.
- Use a non-combustible, sealed foundation.
- Keep the environment clean: Prevent slip and trip hazards.
- Wheels, if installed, must be locked after installation!
- Spilled/leaked thermal fluid must be removed immediately. Observe the proper disposal of thermal fluid and aids. → Page 15, section »Proper disposal of resources and consumables«.
- Observe the floor load bearing capacity for large units.
- Observe the ambient conditions.

2.5 Preparations for operation

2.5.1 Unscrewing/activating the leveling feet (if any)



WARNING

The leveling feet are not unscrewed/activated before switching on the temperature control unit
DEATH OR SERIOUS INJURY DUE TO CRUSHING

- The parking brakes must be activated at the casters (if any) and/or the leveling feet must be unscrewed/activated before the temperature control unit is put into operation.
- The temperature control unit may move if the parking brakes of the casters (if any) are not activated and/or the leveling feet are not unscrewed/activated.

Always unscrew/activate the leveling feet before switching on the temperature control unit. Uneven floors can be compensated by adjusting these leveling feet.

PROCEDURE

- Verify that the parking brakes of the casters (if any) have been activated.
- Unscrew the leveling feet.
- Compensate uneven floors by adjusting these leveling feet, if necessary. Use a spirit level to horizontally align the temperature control unit.
- Tighten the lock screws on the leveling feet after aligning the temperature control unit. This prevents the leveling feet from changing their height during operation.

2.5.2 Installing the glass accessory kit (optional)



CAUTION

The >Probe< [67] is touched in icy condition

SEVERE FROSTBITES CAUSED BY HOUSING PARTS

- The >Probe< [67] must not be touched in icy condition.
- Wear your personnel protective equipment (e.g. temperature-resistant safety gloves, safety goggles, safety footwear).

Installing the glass accessory kit



PROCEDURE

- Install the >Quick-release clamp< [A] and the >O-ring< [B] on the >Dropping funnel< [C].
- Install the >3-way vacuum adapter< [D] (thermal fluid output) on the >Dropping funnel< [C]. A vacuum pump can, for instance, be connected at the >3-way vacuum adapter< [D] (thermal fluid output).
- Install the >Hose fitting< [E] (thermal fluid input) on the >Dropping funnel< [C]. A rotary evaporator can, for instance, be connected to the >Hose fitting< [E] (thermal fluid input).
- Install the >Receiving flask< [G] on the >Receiving flask adapter< [F].
- Check all connections for leaks.

2.5.3 Installing the application



CAUTION

Unintentional tilting of the temperature control unit is not prevented
INJURIES OR MATERIAL DAMAGE

- Tilting of the temperature control unit must be prevented. To do this, have a second person hold the temperature control unit during installation.

Installing the applica-
tion

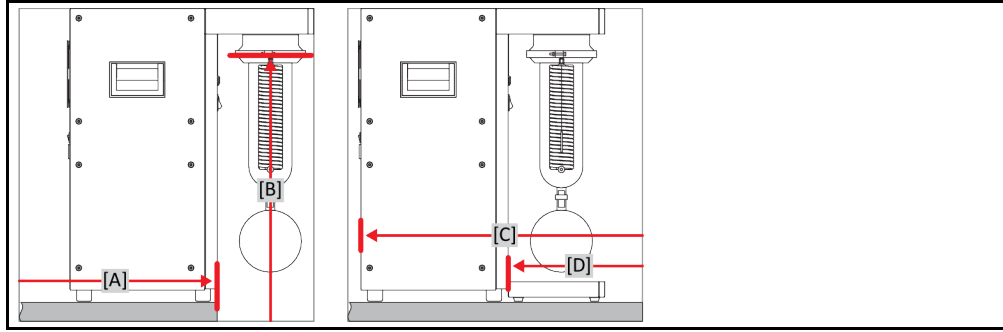

PROCEDURE

- Push the temperature control unit to the front edge of the work surface ([A]). The front of the temperature control unit should be flush with the work surface.
- Secure the temperature control unit against unintentional tilting.
- Install the application ([B]). For this purpose, use an O-ring and a quick release clamp. Depending on the model, the temperature control unit is equipped with two probes. In that case, two applications must be installed.
- Push the temperature control unit back onto the work surface ([C]).
- Place the supplied drip tray underneath the application ([D]). Depending on the model, the temperature control unit is equipped with two probes. In this case, one of the supplied drip trays must be installed underneath each application.
- Check the connection for leaks.

2.5.4 Connecting the functional earth

PROCEDURE

- If required, connect the temperature control unit's >Functional ground terminal< [87] to the building's grounding point. Use a ground strap for this purpose. For the exact position and thread size please refer to the wiring diagram. → From page 49, section »Annex«.

2.6 Connecting to the power supply

INFORMATION

Based on local circumstances, it may be that you need to use an alternative power cable instead of the supplied original power cable. Do not use a power cable that is longer than **3 m** to be able to disconnect the temperature control unit at any time from the mains. Have the mains cable only replaced by a qualified electrician.

2.6.1 Connection using socket with protective earth (PE)

DANGER

Connecting to a power socket without protective earth (PE)
MORTAL DANGER FROM ELECTRIC SHOCK

- Always connect the temperature control unit to safety sockets (PE).

DANGER

Damaged power cable/power cable connection
MORTAL DANGER FROM ELECTRIC SHOCK

- Do not start up the temperature control unit.
- Isolate the temperature control unit from the power supply.
- Have the power supply cable/power supply connection replaced and inspected by an electrician.
- Do not use a power cable that is longer than **3 m**.

NOTE

Incorrect power supply connection
DAMAGE TO THE TEMPERATURE CONTROL UNIT

- Your building's existing power supply voltage and frequency must match the data provided on the rating plate of the temperature control unit.

INFORMATION

In case of uncertainties about an existing protective earth (PE), have the connection inspected by an electrician.

2.6.2 Connection via hard wiring

DANGER

Connection/adjustment to the power supply not carried out by an electrician

MORTAL DANGER FROM ELECTRIC SHOCK

- Have the connection/adjustment to the power supply carried out by an electrician.

DANGER

Damaged power cable/power cable connection

MORTAL DANGER FROM ELECTRIC SHOCK

- Do not start up the temperature control unit.
- Isolate the temperature control unit from the power supply.
- Have the power supply cable/power supply connection replaced and inspected by an electrician.
- Do not use a power cable that is longer than **3 m**.

NOTE

Incorrect power supply connection

DAMAGE TO THE TEMPERATURE CONTROL UNIT

- Your building's existing power supply voltage and frequency must match the data provided on the rating plate of the temperature control unit.

3 Function description

3.1 Function description of the temperature control unit

3.1.1 General functions

The temperature control unit is designed as condensation trap particularly for the recovery of solvents. The temperature control unit is solely intended as a cooling device and must not be used for heating.

3.1.2 Other functions

The following data are displayed on the **display with OLED technology** depending on the model and options: Temperature of the internal and external temperature sensor, setpoint, pressure and flow rate. Use the membrane keyboard to enter the controller settings.

The temperature control unit can easily be integrated in many laboratory automation systems using the **standardly existing RS232 and USB interfaces on the controller**.

An external Pt100 sensor can be connected via the optional **Pt100 process display sensor port**. The temperature measured is displayed on the display.

3.2 Information on the thermal fluids



Non-compliance with the safety data sheet for the thermal fluid to be used

INJURIES

- Risk of injury to the eyes, skin, respiratory tract.
- The safety data sheet for the thermal fluid to be used must be read prior to using it and its content must be respected.
- Observe the local regulations/work instructions.
- Wear your personal protective equipment (e.g. temperature-resistant safety gloves, safety goggles, safety footwear).
- Danger of slipping because floor and work area are contaminated. Clean the workplace; observe the proper disposal of thermal fluid and aids. → Page 15, section »Proper disposal of resources and consumables«.



Non-compliance with the compatibility between the thermal fluid and your temperature control unit

MATERIAL DAMAGE

- Observe the classification of your temperature control unit according to DIN 12876.
- Ensure the following materials are resistant with respect to the thermal fluid: Stainless steel 1.4301/ 1.4401 (V2A).

Thermal fluid: Water

Designation	Specification
Thermal fluid: Water without ethylene glycol	
Use	do not use
Thermal fluid: Water-ethylene glycol mixture	
Use	do not use



A solvent containing gas flow is used as thermal fluid. The solvent is separated by the temperature control unit.

3.3 To be noted when planning the test

INFORMATION Observe the intended operation. → Page 14, section »Proper operation«.

The focus is on your application. Bear in mind that the system performance depends on the temperature.

- Make sure the electrical connection is adequately dimensioned.
- The installation location of the temperature control unit should be selected so as to ensure adequate fresh air, even with water-cooled chillers.
- Select the thermal fluid to be used in such a way that it not only permits the minimum and maximum working temperature but is also suitable with regard to fire point, boiling point, and viscosity. In addition, the thermal fluid must be compatible with all the materials in your system.

3.4 Display and control instruments

The control panel:
Displays and keys

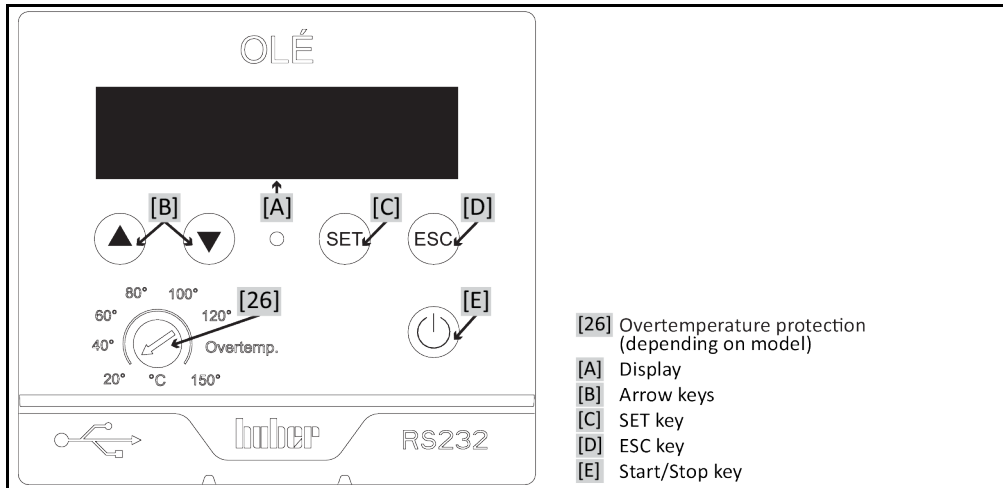

- [26] Overtemperature protection (depending on model)
- [A] Display
- [B] Arrow keys
- [C] SET key
- [D] ESC key
- [E] Start/Stop key

3.4.1 Display

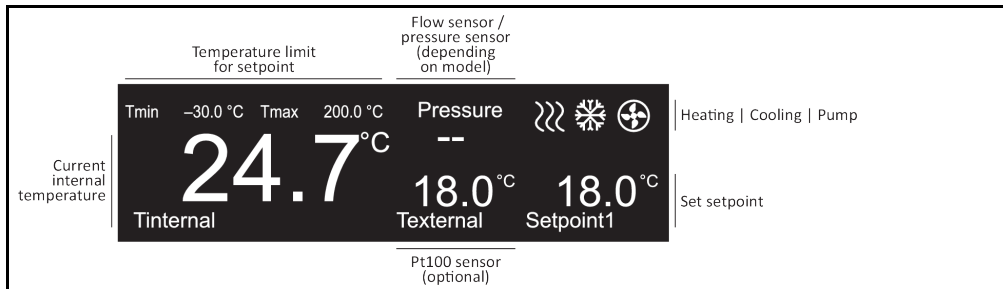

Home screen:
Temperature control is active

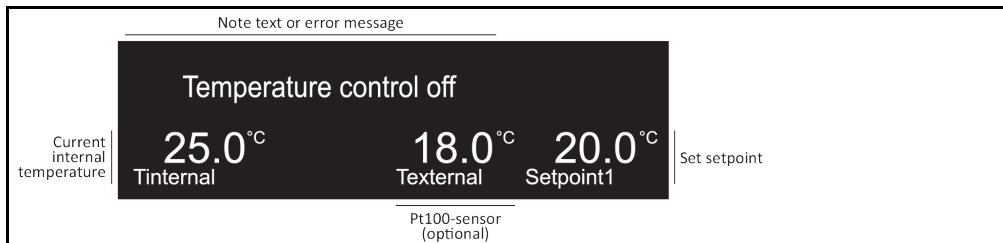

Home screen:
Temperature control is inactive or an error message is displayed



Home screen:
Explanation of the
display

Designation	Description
Temperature limit for setpoint	Display of the setpoint limit. You can set the setpoint only within this range. You can change this limit in the menu item "Protection Options" and then "Setpoint Minimum" and "Setpoint Maximum". Do take the thermal fluid used and the material to be tempered into account when changing these settings. → Page 32, section »Menu function«.
Flow sensor / pressure sensor (optional, depending on model)	Display for the measured values of the built-in flow or pressure sensor. This feature is optional depending on the model and is not available in KISS controllers and other temperature control units. Use the menu item "Sensor Configuration" under "Flow Sensor / Pressure Sensor Display" to change the display or to turn it on and off. → Page 32, section »Menu function«.
 Heating	This symbol is displayed when the temperature control unit heats the thermal fluid. (Only for temperature control units with heating)
 Cooling system	This symbol is displayed when the temperature control unit cools down the thermal fluid.
 Pump	The symbol is displayed when the pump in the temperature control unit runs.
Current internal temperature	Display of the current thermal fluid temperature. The temperature is measured and controlled by the internal temperature sensor.
Pt100 sensor (optional)	Displays the measured value of the external Pt100 process display sensor. This display requires that: 1) the temperature control unit is equipped with a Pt100 port, 2) a Pt100 process display sensor has been attached, 3) the Pt100 process display sensor was placed in the application. You can turn on and off the display in the menu item "Sensor Configuration" under "Display external Pt100 sensor" only if the corresponding interface has been installed. → Page 32, section »Menu function«.
Set setpoint	Displays the setpoint set.
Info text or error message	Displays an info text or error message.

3.4.2 Control instruments

3.4.2.1 Arrow keys



Use the **>Arrow keys< [B]** to enter values (⬆ (+) or ⬇ (-)), to select a menu item (⬅ (arrow left) or ➡ (arrow right)) or to select a different menu item (⬆ (up) or ⬇ (down)). Pressing an arrow key for an extended period changes a value faster. Pressing both **>Arrow keys< [B]** simultaneously calls up the main menu.

3.4.2.2 SET key



Pressing the **>SET key< [C]** on the home screen switches directly to the screen where you can enter the setpoint temperature. It allows you to quickly modify the setpoint temperature. The **>SET key< [C]** is also used to get to a selected menu item or to confirm changes.

3.4.2.3 ESC key



Pressing the **>ESC key<** [D] cancels changes / entries. The display changes to the previous screen without saving a change / entry. Pressing the **>ESC key<** [D] brings you back to the previous screen, all the way to the home screen. Press the **>ESC key<** [D] to acknowledge the alarm sound of an error.

3.4.2.4 Start/Stop key



Start or stop the thermoregulation by pressing the **>Start/Stop button<** [E].

3.4.3 Adjusting settings

Exemplary setting of a numerical value



Exemplary setting by text selection

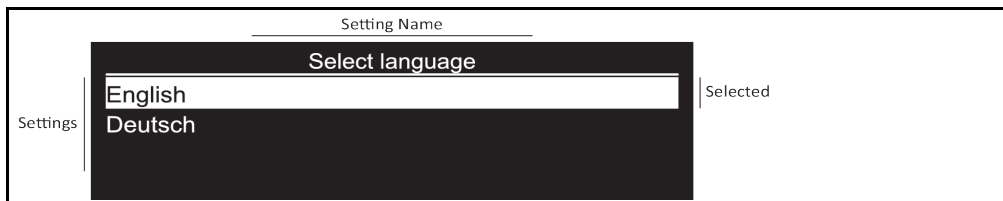

There are two ways to adjust settings:

Numerical settings:

Use the **>Arrow keys<** [B] (▲ (+) or ▼ (-)) and confirm an entry by pressing the **>SET key<** [C]. Pressing an arrow key for an extended period changes a value faster.

Text selection:

Select the text via the **>Arrow keys<** [B] (▲ (up) or ▼ (down)) and confirm your entry by pressing the **>SET key<** [C].





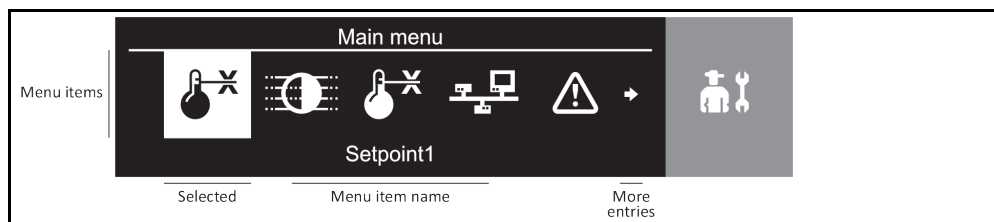

3.5 Menu function

Main menu



Pressing both >Arrow keys< [B] simultaneously calls up the main menu. Some menu items cannot be selected depending on the configuration of the temperature control unit.

Overview of the menu items

Display	Description	KISS	OLÉ
 Setpoint 1	Sets the setpoint. Use the >Arrow keys< [B] to change the setpoint.	X	X
 Adjusting brightness	Adjusting the brightness of the OLED display. Use the >Arrow keys< [B] to change the brightness.	X	X
 Sensor configuration	This menu item makes available: 1) Adjustment of the internal sensor (input options: Offset (K)) 2) Adjustment of the external sensor (input options: Offset (K)) 3) Temperature unit (choose between "Celsius" and "Fahrenheit") 4) Mode (choose between "Internal temperature control", "Venting" and "Circulation") 5) Display of external Pt100 sensor – (activating the display of an external Pt100 process display sensor) 6) Flow sensor / pressure sensor display – (activating the display of the optional flow sensor / pressure sensor)	X O X X O –	X O X X O M
 Interfaces	This menu item makes available: 1) RS232 1 (setting of "Baud rate" and "Mode" (HuberBus)) 2) RS232 2 (setting of "Baud rate" and "Mode" (HuberBus)) 3) USB device (setting of "Baud rate" and "Mode" (HuberBus)) Only Huber service technicians may use the "STBus" mode. 4) Floating contact (selection of "Off", "Alarm" and "Unipump/PCS") 5) External control signal (selection between "Off", "Setpoint2" and "Standby")	X X X – –	X O X O O
 Protection Options	This menu item makes available: 1) Setpoint2 (to input the second setpoint) 2) Setpoint minimum (to input the lower limit of the adjustable setpoint) 3) Setpoint maximum (to input the upper limit of the adjustable setpoint) 4) Power failure automatic (select between "Off" and "Automatic")	– X X X	O X X X
 System	This menu item makes available: 1) Heating output (only with temperature control units; setting in %) 2) Select language (choose between "English" and "German") 3) Cooling bath (select between "Without cooling bath" (Off), "With cooling bath and common power supply" (On) and "With cooling bath and separate power supply" (On)) 4) System information (display different serial numbers (Serial Number) and version statuses) 5) Service menu (only for Huber service technicians. This submenu is password protected) 6) Factory settings (choose between "Continue" and "Cancel")	X X M X X X	M X – X X X
X = standard, O = optional, M = model-dependent – = not possible			

3.6 Functional examples

3.6.1 Selecting a language

PROCEDURE

- Press both >Arrow keys< [B] to invoke the main menu.
- Use the >Arrow keys< [B] to select the menu item "System".
- Press the >SET key< [C] to confirm your selection.
- Use the >Arrow keys< [B] to select the submenu "Select Language".
- Press the >SET key< [C] to confirm your selection.
- Use the >Arrow keys< [B] to select the desired language.
- Press the >SET key< [C] to confirm your selection.
- Press the >ESC key< [D] twice to return to the home screen.

3.6.2 Setting the setpoint

PROCEDURE

Using the home screen to set the setpoint

- Press the >SET key< [C].
- Use the >Arrow keys< [B] (⬆ (+) or ⬇ (-)) to set the new setpoint.
The longer you keep an arrow key pressed the faster the value changes.
- Press the >SET key< [C] to confirm your input.

3.6.3 Changing the Auto-Start function

Following a power outage (or when switching on the temperature control unit), this function can be used to determine how the temperature control unit is supposed to respond.

Auto-Start function is turned off

The temperature control is started only by manual input when the temperature control unit is turned on.

Auto-Start function is turned on

The temperature control unit is set to the same state it was in before the power outage. For example, before the power outage: Thermoregulation is off; after power outage: Thermoregulation is off. If temperature control is active during a power outage, the process will automatically continue after the power outage.

PROCEDURE

- Press both >Arrow keys< [B] to invoke the main menu.
- Use the >Arrow keys< [B] to select the menu item "Protection Options".
- Press the >SET key< [C] to confirm your selection.
- Use the >Arrow keys< [B] to select the submenu "Power Failure Automatic".
- Press the >SET key< [C] to confirm your selection.
- Use the >Arrow keys< [B] to select the desired setting.
- Press the >SET key< [C] to confirm your selection.
- Press the >ESC key< [D] twice to return to the home screen.

4 Setup mode

4.1 Setup mode

CAUTION

Moving the temperature control unit during operation
SERIOUS BURNS/FREEZING OF THE HOUSING PARTS/ESCAPING THERMAL FLUID
➤ Do not move temperature control units that are in operation.

4.1.1 Turning on the temperature control unit

PROCEDURE

- Before you turn on the temperature control unit using the **>Mains switch<** [37]:
- A condensation trap must be installed. → Page 25, section »**Installing the application**«.
- Turn on the temperature control unit using the **>Mains switch<** [37].
The temperature control is **switched off**.

4.1.2 Turning off the temperature control unit

NOTE

The power supply is interrupted before the temperature control process was terminated properly

DAMAGE TO THE TEMPERATURE CONTROL UNIT

- End the temperature control process before the power supply is interrupted (by switching off or disconnecting from the voltage).

INFORMATION

Do not switch off the temperature control unit while the temperature control process is running. Only switch off the temperature control unit after the temperature control process is finished.
→ Page 35, section »**Ending the temperature control process**«.

PROCEDURE

- Switch off the temperature control unit using the **>Mains switch<** [37].
Switch off the temperature control unit only when **no** temperature control process is activated!
→ Page 35, section »**Ending the temperature control process**«.

5 Normal operation

5.1 Automatic operation

CAUTION**Extremely hot / cold surfaces, connections and thermal fluids****BURNS/FREEZING OF LIMBS**

- Surfaces, connections and tempered thermal fluids can be extremely hot or cold depending on the operating mode.
- Avoid direct contact with surfaces, connections and thermal fluids!
- Wear your personnel protective equipment (e.g. temperature-resistant safety gloves, safety goggles).

5.1.1 Temperature control

5.1.1.1 Starting the temperature control process

The temperature control can be started when a condensation trap has been installed and filled.

PROCEDURE

- Switch on the temperature control unit. → Page 34, section »Turning on the temperature control unit«.
- Set the desired setpoint. → Page 33, section »Setting the setpoint«. The setpoint can **not** be changed while a temperature control process is running.
- With the temperature control unit switched on and the temperature control process/circulation stopped, press the **>Start/Stop button< [E]**.
The temperature control process starts.

5.1.1.2 Ending the temperature control process

Thermoregulation can be terminated at any time.

PROCEDURE

- With the temperature control unit switched on and the temperature control process/circulation stopped, press the **>Start/Stop button< [E]**.
Thermoregulation starts. The temperature control unit is in standby mode.
- Switch off the temperature control unit. → Page 34, section »Turning off the temperature control unit«.

6 Interfaces and software update

NOTE

The specifications of the interface used are not being met.

PROPERTY DAMAGE

➤ Only connect components that meet the specifications of the interface used.

6.1 Controller interfaces

Standard interfaces on the OLÉ controller



6.1.1 USB-2.0 interface

INFORMATION

The interfaces used must meet the specifications of the generally accepted standards. The necessary drivers for the interface can be found at: www.ftdichip.com/Drivers/VCP.htm

6.1.1.1 USB-2.0 interface, device



USB-2.0 connection (for Mini-B connector) for communicating with a computer.

6.1.2 RS232 jack



A PC, a SPS or a Process Control System (PCS) can be connected to this jack for remote control of the controller electronics. Before plugging in the cable, check the settings in the “Interfaces” category and adjust if necessary.

INFORMATION

The interfaces used must meet the specifications of the generally accepted standards.

Pin assignment (front view)



Pin assignment

Pin	Signal	Description
2	RxD	Receive Data
3	TxD	Transmit Data
5	GND	Signal GND

6.2 Data communication

The communication via the RS232 interface is a master-slave communication. The Master (e.g. PC or PLC) starts a communication and the slave (the temperature control unit) will only respond to a request.

Transmission format:

8 data bits, 1 stop bit, no parity, no handshake

These parameters are non-adjustable and cannot be changed! The baud rate can be set in a range from 9600 baud to 115200 baud.

Time response (timing):

The data flow of a command must not be interrupted. Pauses of more than 100 ms between the characters of a command result in the receiver aborting the incoming command. The temperature control unit will always send a response for a correctly received command. The next command can be sent once a complete response was received. The typical response time is less than 300 ms.

INFORMATION

You need the software "SpyControl" to transmit commands. The software can be downloaded from the download area of www.huber-online.com.

6.2.1 LAI commands

There are 3 commands to communicate LAI commands to the temperature control unit:

1. "V" (Verify) – to query the device ID,
2. "L" (limit) – to query the device limits,
3. "G" (General) – to control and query the temperature control unit.

The send commands always begin with "[M01", answers always with "[S01", followed by the command qualifier "V" (Verify), "L" (Limits) or "G" (General). The next two bytes specify the length or the response of the command. A check sum is transmitted to increase data safety. The checksum is the 1 byte sum of all hex values from the start character to the last character before the checksum. It is appended to the end of the command or the response and then finished off with the end character CR ("\r", 0Dh).

Structure of a send command

Byte	Command	Response	Description
1 Byte	[[Start character, fix
2 Byte	M	C	Identification of the transmitter (M = Master, S = Slave)
3 bytes	0	0	Slave address, fix
4 bytes	1	1	Slave address, fix
5 bytes	V / L / G	V / L / G	Command qualifier (V = Verify, L = Limit, G = General)
6 bytes	0	1	Length of command / response (example)
7 bytes	7	4	Length of command / response (example)
n Bytes	x	x	If applicable, content; the number of bytes depends on the command
I-2 byte	C	C	Checksum (example)
I-1 byte	6	1	Checksum (example)
I byte	\r	\r	End-of-text character CR

6.2.1.1 Command "V" (Verify)

This command is provided to check the presence of a slave and query its ID.

Byte	ASCII	Hex	Description
Master sends: [M01V07C6\r			
1. Byte	[5Bh	Start character
2. Byte	M	4Dh	Master ID
3. Byte	0	30h	Slave address
4. Byte	1	31h	Slave address
5. Byte	V	56h	Command qualifier
6. Byte	0	30h	Length of data field (0)
7. Byte	7	37h	Length of data field (7)
8. Byte	C	43h	Checksum
9. Byte	6	36h	Checksum
10. Byte	\r	0Dh	End character CR
The checksum is formed from bytes 1 to 7: $5Bh + 4Dh + 30h + 31h + 56h + 30h + 37h = 1C6h = 1 \text{ byte sum} = C6h$ The hex value C6h is appended as two ASCII characters "C" (43h) and "6" (36h).			
The slave responds: [S01V14Huber ControlC1\r The 13 bytes of the data set "Huber Control" plus the 7 bytes in front of the data set result in a data field length of 20 bytes = 14h bytes.			

6.2.1.2 Command "L" (Limit)

This command is used to query the setpoint limits.

Byte	ASCII	Hex	Description
Master sends: [M01LOF*****1B\r			
The slave responds: [S01L17F4484E20F4484E2045\r			

A response always includes four limit values (starting from the eighth byte):

1. Lower setpoint limit (4 bytes),
2. upper setpoint limits (4 bytes),
3. lower working range limit (4 bytes),
4. upper working range limit (4 bytes).

The working range limits are device-specific and cannot be changed. The lower setpoint limit can not be lower than the lower working range limit and the upper setpoint limit can not exceed the upper working range limit.

The two bytes before the last byte contain the checksum and the last byte of the response contains the end character (CR).

Each of the four values is expressed as a hex value. The values are signed, where 1 bit corresponds to 0.01 K. Thus a number range from 0000h to 7FFFh, i.e. from 0.00 °C to 327.67 °C, can be represented. Negative numbers are represented from FFFFh to 8000h, i.e. from -0.01 °C to -327.66 °C. Thus the four individual ASCII characters "F448" correspond to a 16-bit hex value of F448h and thus a temperature of -30 °C. → Page 39, section »Command "G" (General)«.

6.2.1.3 Command “G” (General)

This command transmits the most important temperatures and status information in a cycle. A modified setpoint is not stored in the permanent memory, i.e. this value is lost when switching off the machine.

Structure Command
“G” (General)

Byte	ASCII	Hex	Description
Master sends: [M01G0Dsattttpp\r			
1. Byte	[5Bh	Start character
2. Byte	M	4Dh	Master ID
3. Byte	0	30h	Slave address
4. Byte	1	31h	Slave address
5. Byte	G	47h	Command qualifier
6. Byte	0	30h	Length of the command: 0Dh = 13 bytes (number of bytes without checksum and end character)
7. Byte	D	44h	
8. Byte	s: C / I / O / *	43h / 49h / 4Fh / 2Ah	Temperature control mode Meaning of the characters in the send string: “C” (43h) = Circulation, switch circulation on; “I” (49h) = Turn internal temperature control on; “O” (4Fh) = Off, turn temperature control off; “*” (2 Ah) = Do not change the current state.
9. Byte	a: 0 / 1 / *	30h / 31h / 2Ah	Alarm acknowledgment Meaning of the characters in the send string: “0” (30h) = No alarm acknowledgment; “1” (31h) = Any pending alarm tone is acknowledged; “*” (2 Ah) = Do not change the current state.
10. Byte	t	tttt / ****	Query or set the setpoint Meaning of the characters in the send string: Setpoint with 16-bit resolution (2 bytes, thus 4 ASCII characters) “tttt” = 0000h (0.00 °C) to 7FFFh (327.67 °C) FFFFh (-0.01 °C) to 8000h (-327.68 °C) 0190h corresponds to +4 °C, (30h, 31h, 39h, 30h) FE70h corresponds to -4 °C (46h, 45h, 37h, 30h) “****” (2Ah, 2Ah, 2Ah, 2Ah) = no change to the setpoint, setpoint is only queried
11. Byte	t		
12. Byte	t		
13. Byte	t		
14. Byte	p	Checksum	Checksum
15. Byte	p	Checksum	It is generated from bytes 1 to 13.
16. Byte	\r	0Dh	End character CR
The slave responds: [S01G15sattttiiiiieepp\r			
1. Byte	[5Bh	Start character
2. Byte	C	53h	Slave ID
3. Byte	0	30h	Slave address
4. Byte	1	31h	Slave address
5. Byte	G	47h	Command qualifier
6. Byte	1	31h	Length of response: 15h = 21 Bytes
7. Byte	5	35h	
8. Byte	s: C / I / O	43h / 49h / 4Fh	Temperature control mode Meaning of the characters in the response string: “C” (43h) = Circulation, circulation is on; “I” (49h) = Internal temperature control is on; “O” (4Fh) = Off, temperature control is off.

Byte	ASCII	Hex	Description
9. Byte	a: 0 / 1	30h / 31h	Alarm status Meaning of the characters in the response string: "0" (30h) = No alarm; "1" (31h) = Any number other than "0" is an alarm
10. Byte	t	tttt / ****	Query or set the setpoint Meaning of the characters in the send string: Setpoint with 16-bit resolution (2 bytes, thus 4 ASCII characters) "tttt" = 0000h (0.00 °C) to 7FFFh (327.67 °C) FFFFh (-0.01 °C) to 8000h (-327.68 °C) 0190h corresponds to +4 °C, (30h, 31h, 39h, 30h) FE70h corresponds to -4 °C (46h, 45h, 37h, 30h) "****" (2Ah, 2Ah, 2Ah, 2Ah) = no change to the setpoint, setpoint is only queried
11. Byte	t		
12. Byte	t		
13. Byte	t		
14. Byte	i	iiii	Internal actual value Same format as setpoint
15. Byte	i		
16. Byte	i		
17. Byte	i		
18. Byte	e	eeee	External actual value Same format as setpoint, depends on device configuration
19. Byte	e		
20. Byte	e		
21. Byte	e		
22. Byte	p	Checksum	Checksum It is generated from bytes 1 to 21.
23. Byte	p	Checksum	
24. Byte	\r	0Dh	End character CR

Example:

The temperature control mode and the alarm status should remain unchanged (each "**") and a setpoint of -4.00 °C (FE70) is to be set.

The master sends: **[M01G0D**FE700A\r**

The slave responds (for example): **[S01G1500FE7009A4C504E7\r**

The temperature control unit is turned off ("O"), there is no alarm ("0"), the setpoint of -4.00 °C was set (FE70), the actual value is 24.68 °C (09A4), "C504" corresponds to -151.00 °C and indicates that no external temperature sensor is installed or connected.

6.2.2 PP commands

There is another set of commands to make the communication with the temperature control unit easy. The PP commands can be used, e.g. in conjunction with simple terminal programs. The calculation of a checksum has therefore been omitted and the commands kept very simple. Each command is terminated with Carriage Return ('\r', 0Dh) and Linefeed ('\n', 0Ah). There are read and write commands. Each correct command causes a response from the temperature control unit. Temperature and setpoint values are represented by a five-digit number, which corresponds to the temperature being expressed in hundredths of a degree (without decimal point).

Available read commands

Function	Master sends	Slave responds	Description
Read the setpoint	SP?\r\n	SP +02500\r\n	The setpoint is set to 25.00 °C.
Read the internal actual value	TI?\r\n	TI +02499\r\n	Currently, the internal actual value is 24.99 °C.
Read the external actual value	TE?\r\n	TE +02499\r\n	Currently, the external actual value is 24.99 °C.
		TE -15100\r\n	An external sensor is not connected or does not exist.
Read the temperature control mode	CA?\r\n	CA +00000\r\n	Temperature control and circulation are inactive.
		CA +00001\r\n	Temperature control and circulation are active.

Available write commands

Function	Master sends	Slave responds	Description
Setting the setpoint	SP@ -01234\r\n	SP -01234\r\n	The setpoint is set to -12.34 °C.
Starting the temperature control unit	CA@ 00001\r\n	CA +00001\r\n	The temperature control process is started.
Stopping the temperature control unit	CA@ 00000\r\n	CA +00000\r\n	The temperature control process is stopped.

7 Service/maintenance

7.1 Displays in the event of faults

An alarm signal (xx Hz) is sounded in the event of a fault and the temperature control unit displays an alarm or warning message on the OLED display.

Overview of messages

Code	Cause	Effect, measure
001	Overtemperature alarm The internal temperature is above the set value of the overtemperature protection. The overtemperature protection was triggered.	The internal temperature of the thermal fluid is in the upper allowable extreme range. The temperature control unit can be turned on again only when the temperature of the thermal fluid has returned to normal parameters. Check whether the thermal fluid used matches your required parameters if overtemperatures repeatedly shut down the unit.
002	Tmax exceeded The internal temperature is above the set setpoint limit.	The internal temperature of the thermal fluid is above the setpoint limit set in the controller. Control continues.
003	Tmin undercut The internal temperature is below the set setpoint limit.	The internal temperature of the thermal fluid is below the setpoint limit set in the controller. Control continues.
004	Error float test	Check the thermal fluid level. KISS: Is the float blocked or sticky? Please contact Customer Support if the thermal fluid level is sufficient and the float of the KISS controller moves freely.
005	Low-level alarm No enable signal, level alarm	Control is inactive. (Pump off, compressor off, heating off) Check the fill level of the thermal fluid. Restart impossible until the thermal fluid level is OK.
006	Overpressure cutout triggered The pressure in the condenser is too high. The overpressure cutout (pressure switch) has triggered.	Temperature and pressure increase in the condenser. An overpressure cutout (pressure switch) is installed to protect the temperature control unit against excessive pressure. Water cooling: a.) Is the cooling water supply correctly connected? b.) Is the suction strainer (dirt trap) clogged? c.) What is the cooling water temperature, the cooling water flow rate and the cooling water pressure? Air cooling: a.) Is the heat exchanger or the grille dirty? b.) Does the fan turn if the cooling machine is switched on? If the fan does not turn: Contact Customer Support.
009 011	Sensor F1 short Sensor F2 short Short-circuit at the internal temperature sensor F1 or at the external temperature sensor F2.	Control is inactive. (Pump off, compressor off, heating off) Check the sensor.
010 012	Sensor F1 open Sensor F2 open The internal temperature sensor F1 or the external temperature sensor F2 is open.	Control is inactive. (Pump off, compressor off, heating off) Check the sensor.

Code	Cause	Effect, measure
033	Error EP0 (Flash)	Please contact Customer Support.
034	Error EP1 (EEPROM)	
035	Error EP2 (NVRAM)	
036	Synchronization	
037	Parameters not equal	
038	Invalid status	
039	Error safety chip	
042	Pump protection activated The pump motor is overheated.	Check the ambient conditions. Check the viscosity of the thermal fluid. Turn the temperature control unit off and let it cool down.

7.2 Electrical fuse (if available)

The overcurrent circuit breakers for all pole breaking (L and N) are located at the back of the temperature control unit. In case of a fault (no function and no display on the temperature control unit) please first check if the overcurrent circuit breaker has tripped. If the overcurrent circuit breakers immediately trip again after the reset: Unplug the power cord and immediately contact Customer Support. → Page 48, section »Contact data«.

7.3 Maintenance



Cleaning/maintenance while the temperature control unit is operating

MORTAL DANGER FROM ELECTRIC SHOCK

- Stop an ongoing temperature control process.
- Turn off the temperature control unit.
- Also disconnect the temperature control unit from the power supply.



Performing maintenance work not described in these operation manual

MATERIAL DAMAGE ON THE TEMPERATURE CONTROL UNIT

- Please contact Huber for maintenance work that is not described in these operation manual.
- Maintenance work not described in these operation manual is reserved for qualified specialists trained by Huber.
- Safety-relevant components may only be replaced by equivalent ones. The specified safety values for the respective component must be observed.

7.3.1 Function check and visual inspection

Control intervals

Cooling*	Description	Maintenance interval	Comment	Person responsible
A/W	Visually inspect hoses and hose connections	Prior to switching on the temperature control unit	Exchange leaking hoses and hose connections prior to switching on the temperature control unit.	Operating company and/or operators
A/W	Check the fill level in the drip tray	Prior to switching on the temperature control unit	Check the fill level in the collecting container. Empty as required. Observe the proper disposal. → Page 15, section »Proper disposal of resources and consumables«.	Operating company and/or operators
A/W	Check the power supply cable	Prior to switching on the temperature control unit or on relocation	Do not start the temperature control unit if the power supply cable is damaged.	Qualified electrician (BGV A3)

Cooling*	Description	Maintenance interval	Comment	Person responsible
A	Clean the perforated sheet	As required	Clean the perforated sheet of the temperature control unit with a damp cloth	Operating company
A/W	Thermal fluid inspection	As required	–	Operating company and/or operators
A	Check the liquefier fins	As required, after 3 months at the latest	→ Page 44, section »Clean liquefier fins (air-cooled temperature control unit)«	Operating company and/or operators
A/W	Check the temperature control unit for damage and stability	Every 12 months or after a change of location	–	Operating company and/or operators
A/W	Exchange safety-relevant electric and electromechanical components	20 years	Have the exchange only carried out by certified personnel (such as Huber service engineers). Please contact Customer Support. → Page 48, section »Contact data«	Operating company

*A = Air cooling; W = Water cooling; U = Applicable only for Unistats

7.3.2 Clean liquefier fins (air-cooled temperature control unit)

CAUTION

Manual cleaning

RISK OF BEING CUT ON THE LIQUEFIER FINS

- Wear suitable cut-resistant gloves for cleaning work.
- Depending on the ambient conditions, use cleaning equipment such as vacuum cleaners and/or a hand brush/brush. Follow the local regulations when cleaning. Do not clean the liquefier fins in a clean room with items like a brush and do not use a vacuum cleaner without an extra-fine particle filter.

NOTE

Cleaning using pointed or sharp-edged tools

DAMAGE TO THE LIQUEFIER FINS

- Clean the liquefier fins using suitable cleaning appliances.

INFORMATION

Make sure there is adequate ventilation (removal of waste heat, fresh air supply) for the temperature control unit, in case of **air cooling, maintain wall clearance**. → Page 19, section »Exemplary illustrations of the cooling variants« and → Page 22, section »Ambient conditions«. The liquefier fins must be cleaned (dust) from time to time as only then will the temperature control unit perform at its maximum cooling capacity.

PROCEDURE

Liquefier fins on lower surface

- Switch off the temperature control unit.
- Disconnect the temperature control unit from the power supply.
- Tilt the temperature control unit to its side. Make sure the cooling coil is not bent.
- Clean the liquefier fins using suitable cleaning appliances. Observe the local regulations and ambient conditions when selecting cleaning appliances.
- Make sure the liquefier fins are not damaged or deformed as this will impair the air flow.
- Put the temperature control unit upright immediately after cleaning the liquefier fins and wait for **60 minutes** to allow the compressor oil to flow back.
- Connect the temperature control unit to the power supply.
- Switch on the temperature control unit.

7.4 Cleaning the surfaces

CAUTION

Extremely hot / cold surfaces, connections and thermal fluids

BURNS/FREEZING OF LIMBS

- Surfaces, connections and tempered thermal fluids can be extremely hot or cold depending on the operating mode.
- Avoid direct contact with surfaces, connections and thermal fluids!
- Wear your personnel protective equipment (e.g. temperature-resistant safety gloves, safety goggles).

NOTE

Exposed plug contacts

DAMAGE CAUSED BY FLUID INGRESS

- Protect unused plug contacts with the protective caps supplied.
- Clean surfaces only with a damp cloth.

A standard stainless steel cleaning agent is suitable for cleaning the stainless steel surfaces. Carefully clean painted surfaces (damp only) using a solution of sensitive-fabrics detergent. Observe the proper disposal of thermal fluid and aids. → Page 15, section »Proper disposal of resources and consumables«.

7.5 Plug contacts

NOTE

Exposed plug contacts

DAMAGE CAUSED BY FLUID INGRESS

- Protect unused plug contacts with the protective caps supplied.
- Clean surfaces only with a damp cloth.

Protective caps are supplied for all plug contacts. Make sure that any plug contacts not required are protective with the caps.

7.6 Decontamination/repairs

CAUTION

Returning a not decontaminated temperature control unit for repair

PHYSICAL INJURY AND PROPERTY DAMAGE CAUSED BY HAZARDOUS MATERIALS IN OR ON THE TEMPERATURE CONTROL UNIT

- Carry out appropriate decontamination.
- The decontamination process depends on the type and quantity of the materials used.
- Consult the relevant safety data sheet.
- You will find a prepared return receipt at www.huber-online.com.

As the responsible body you are responsible for carrying out decontamination **before** third-party personnel come into contact with the temperature control unit / accessory. Decontamination must be carried out **before** the temperature control unit / accessory is returned for repair or inspection. Attach a clearly visible written notice stating that the temperature control unit / accessory has been decontaminated.

To simplify the process, we have prepared a form for you. This is available for download at www.huber-online.com.

8 Shutting down

8.1 Safety instructions and basic principles



DANGER

Connection/adjustment to the power supply not carried out by an electrician and/or connection to a power socket without protective earth (PE)

MORTAL DANGER FROM ELECTRIC SHOCK

- Have the connection/adjustment to the power supply carried out by an electrician.
- Always connect the temperature control unit to safety sockets (PE).



DANGER

Damaged power cable/power cable connection

MORTAL DANGER FROM ELECTRIC SHOCK

- Do not start up the temperature control unit.
- Isolate the temperature control unit from the power supply.
- Have the power supply cable/power supply connection replaced and inspected by an electrician.
- Do not use a power cable that is longer than **3 m**.



WARNING

Risk of tipping due to unstable temperature control unit

SERIOUS INJURY AND PROPERTY DAMAGE

- Avoid risk of tipping due to unstable temperature control unit.



CAUTION

Non-compliance with the safety data sheet for the thermal fluid to be used

INJURIES

- Risk of injury to the eyes, skin, respiratory tract.
- The safety data sheet for the thermal fluid to be used must be read prior to using it and its content must be respected.
- Observe the local regulations/work instructions.
- Wear your personal protective equipment (e.g. temperature-resistant safety gloves, safety goggles, safety footwear).
- Danger of slipping because floor and work area are contaminated. Clean the workplace; observe the proper disposal of thermal fluid and aids. → Page 15, section »**Proper disposal of resources and consumables**«.

INFORMATION

All safety instructions are important and must be followed accordingly during working operations!

8.2 Switch-off

PROCEDURE

- Turn off the temperature control unit.
- Disconnect the temperature control unit from the power supply connection.

8.3 Emptying the application

PROCEDURE

- Empty the application.

8.4 Uninstalling the application

PROCEDURE

- Disconnect the application from the temperature control unit. For temperature control units with two probes, both applications must be deinstalled from the temperature control unit.

8.5 Packing

Always use the original packaging! → Page 22, section »Unpacking«.

8.6 Shipping

NOTE

Temperature control unit transported in a horizontal position

DAMAGE TO THE COMPRESSOR

- Only transport the temperature control unit in an upright position.

NOTE

Temperature control unit transported incorrectly

PROPERTY DAMAGE

- Do not transport by truck on the castors or feet.
- Comply all requirements in this section to avoid damage to the temperature control unit.

Pallet with squared timber for free-standing units

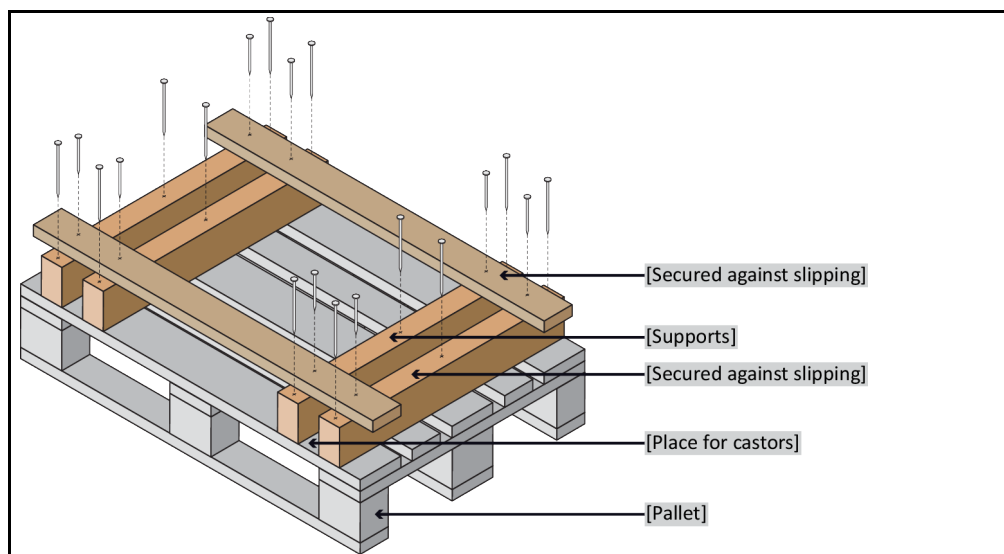

Transport using the lugs, if fitted, on the top of the temperature control unit. Do not transport the temperature control unit alone and without aids.

- Always use the original packaging for transportation.
- Indicate the upright transport position with arrows on the packaging.
- Always transport the temperature control unit upright on a pallet!
- Protect attachments from damage during transportation!
- During transport, place the temperature control unit on squared timber to protect the casters/feet.
- Secure with tensioning belts/lashing straps that are suitable for the weight.
- Additionally secure (depending on model) with plastic film, cardboard and straps.

8.7 Disposal

The operating company must observe the national and local regulations for the proper disposal.

CAUTION

Uncontrolled or incorrect opening of the coolant circuit

RISK OF INJURY AND ENVIRONMENTAL DAMAGE

- Work on the coolant circuit and disposal of the refrigerant must be carried out by approved refrigeration/air-conditioning system contractors.

NOTE**Improper disposal****ENVIRONMENTAL DAMAGE**

- Spilled/leaked thermal fluid must be discarded immediately and correctly. Observe the proper disposal of thermal fluid and aids. → Page 15 the section »**Proper disposal of resources and consumables**«.
- To avoid environmental damage, have “disused” temperature control units disposed of exclusively by approved waste management companies (e.g. refrigeration and air conditioning companies).

Huber temperature control units and Huber accessories are made of high quality, recyclable materials. For example: Stainless steel 1.4301 / 1.4401 (V2A), copper, nickel, FKM, Perbunan, NBR, ceramic, carbon, Al-Oxid, red brass, brass, nickel-plated brass and silver solder. Proper recycling of the temperature control unit and accessories can actively help reduce CO₂ emissions in the production of these materials. Follow the laws and regulations of your jurisdiction when disposing material.

8.8 Contact data

INFORMATION

Contact your supplier or local specialist retailer **prior** to returning the temperature control unit. The contact data can be found on our homepage www.huber-online.com under the heading „Contact“. Please keep the serial number of the temperature control unit ready. The serial number can be found on the nameplate of the temperature control unit.

8.8.1 Telephone number: Customer Support

If your country is not mentioned in the list below: The responsible service partner can be found on our homepage www.huber-online.com under the heading „Contact“.

- Huber Deutschland: +49 781 9603 244
- Huber China: +86 (20) 89001381
- Huber India: +91 80 2364 7966
- Huber Ireland: +44 1773 82 3369
- Huber Italia: +39 0331 181493
- Huber Swiss: +41 (0) 41 854 10 10
- Huber UK: +44 1773 82 3369
- Huber USA: +1 800 726 4877 | +1 919 674 4266

8.8.2 Telephone number: Sales

Telephone: +49-781-9603-123

8.8.3 Email address: Customer Support

Email: support@huber-online.com

8.9 Clearance certificate

This certificate must be enclosed with the temperature control unit. → Page 45, section »**Decontamination/repairs**«.

9 Annex

Inspired by **temperature** designed for you

Peter Huber Kältemaschinenbau SE
Werner-von-Siemens-Str. 1
77656 Offenburg / Germany

Telefon +49 (0)781 9603-0
Telefax +49 (0)781 57211

info@huber-online.com
www.huber-online.com

Technischer Service: +49 (0)781 9603-244

-125 °C ... +425 °C

huber